	Form Title:	<p align="center"><b>ENGINEERING BULLETIN</b></p>	Document #:	<b>EB-02-17</b>
				Revision:
	Document Title:	<p align="center"><b>Wet-R-Dri Valve Product Family Changes and New Product Introduction</b></p>	Date:	<b>Jun. 2018</b>
				Page:

**Description of Bulletin:** This bulletin provides details on changes to Betts' Wet-R-Dri product line. A new lightweight aluminum handle will be available and will be used in a new metering handle assembly (28981ALEY). A new metering valve will replace the old metering and locking valve. Also, a hydraulic actuated option is now available.

**Background Details:**

Wet-R-Dri ordering information is shown on the following page. Not all options are available. Contact Betts Sales Department for availability.

<b>WD</b>	<b>4</b>	<b>0</b>	<b>0</b>	<b>AL</b>	<b>VB</b>	<b>Suffix</b>
-----------	----------	----------	----------	-----------	-----------	---------------

Size	Body Type	Model Type /Actuation	Body Material	Disc Material	Suffix Info. COMMONLY USED
2" 3" 4" 5" 6" 8" 12"	0=TTMA BODY	<b>0=OBSOLETE MODEL NON-DETENT/ MANUAL REPLACE W/ MODEL TYPE 1</b>	<b>AL</b> ALUMINUM	<b>B</b> NITRILE (BUNA N)	<b>001</b> E-COATED VALVE
	1=TTMA BODY W/ ACTUATOR (model types 7,8,9)	<b>1=DETENT MODEL/ MANUAL</b>	<b>GI</b> CAST IRON	<b>E</b> EPDM	<b>002</b> GREASE FITTINGS IN SHAFT
	2=ASA BODY	<b>2=OBSOLETE MODEL LOCKING/ MANUAL REPLACE W/ MODEL TYPE 6</b>		<b>OP</b> WHITE FDA NITRILE (BUNA N) W/ SS SOCKETS	<b>004</b> VALVE ONLY LESS HANDLE OR ACTUATOR
	3=ASA BODY W/ ACTUATOR (model types 7,8,9)	<b>3= OBSOLETE MODEL SPRING LOADED LOCKING/ MANUAL REPLACE W/ MODEL TYPE 6</b>			<b>014</b> ASA BODY W/ TTMA DRILLING
	4	<b>4=OBSOLETE MODEL METERING/ MANUAL REPLACE W/ MODEL TYPE 6</b>		<b>VF</b> FKM GFLT-S	<b>019</b> SS SHAFTS W/ SS LINER
	5	<b>5= OBSOLETE MODEL SPRING LOADED/ MANUAL REPLACE W/ MODEL TYPE 6</b>		<b>VB</b> FKM TYPE B	<b>032</b> LEFT HAND OPERATION
	6	<b>6=METERING/ MANUAL (8- POSITION) HANDLE 28981ALEY</b>		<b>U</b> URETHANE	<b>046</b> E-COATED VALVE LEFT HAND OPERATION
	8	<b>7=AIR-AIR MODEL/ PNEUMATIC ACTUATOR</b>		<b>WB</b> WHITE FDA NITRILE (BUNA N)	<b>089</b> 225 PSI TESTED W/ FLUOROSILICONE O-RINGS
	12	<b>8=HYDRAULIC MODEL/ HYDRAULIC ACTUATOR</b>			<b>095</b> AIR ACTUATED NORMALLY OPEN E-COATED VALVE
	<b>9=AIR-SPRING MODEL/ PNEUMATIC ACTUATOR</b>				

Betts Industries Inc. Authorized Distributor:

**Tank Truck Service & Sales, Inc.** Warren, Michigan 800-482-2678 [www.tanktruckservice.com](http://www.tanktruckservice.com)

	Form Title:	<p align="center"><b>ENGINEERING BULLETIN</b></p>	Document #:	<b>EB-02-17</b>
				Revision:
	Document Title:	<p align="center"><b>Wet-R-Dri Valve Product Family Changes and New Product Introduction</b></p>	Date:	<b>Jun. 2018</b>
				Page:

**Part Number Changes:**

Betts' non-detent WRD models (Model Type 0) are now obsolete and replaced with the detent style models (Model Type 1). Example part numbers shown below.

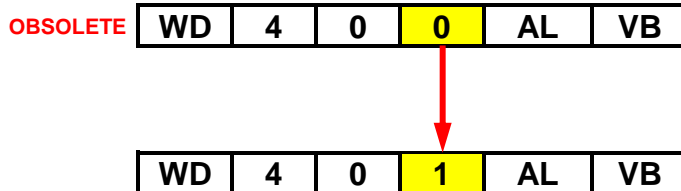

The detent model has a detent spring and ball which assist in holding the disc in the open and closed position.

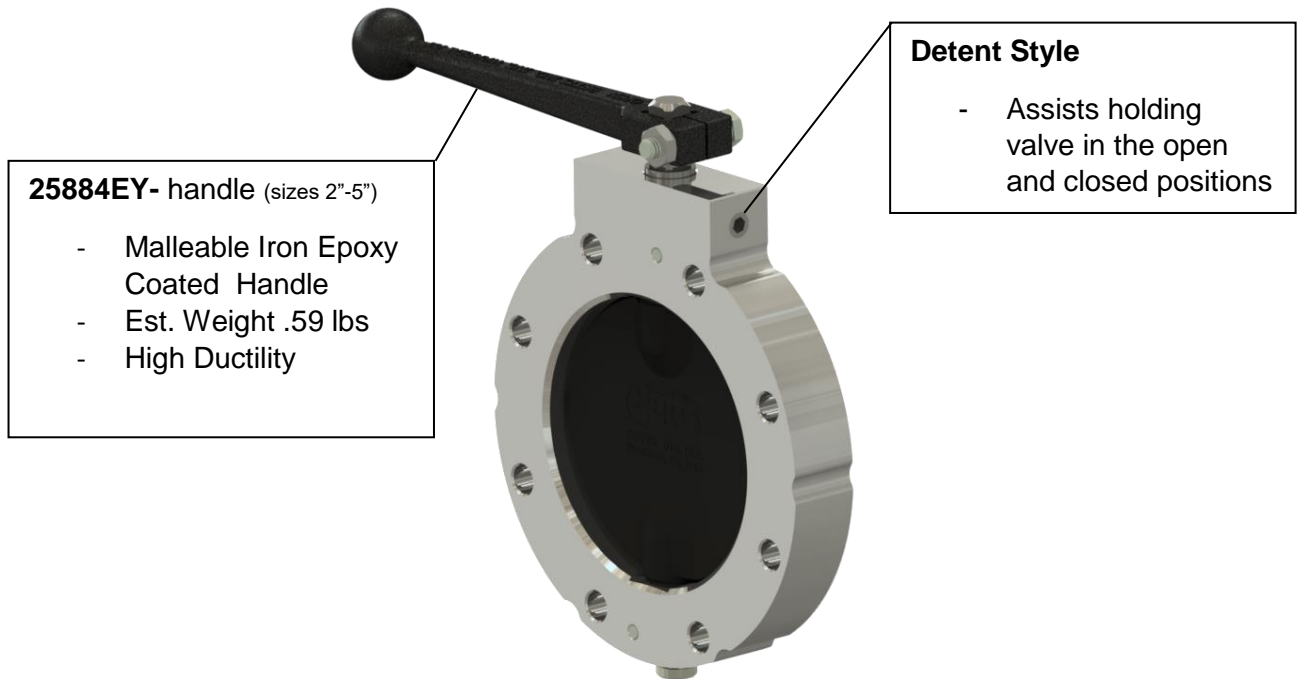

Betts now offers a lightweight longer handle option for valve sizes 2-5". To order a valve with this option add suffix **004** (valve less handle) to the end of the part number and also order 28967ALEY separately.

**Lightweight Aluminum Handle Option**

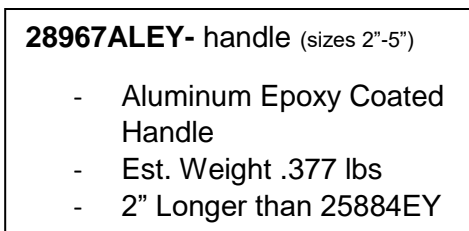

Betts Industries Inc. Authorized Distributor:

	Form Title:	<b>ENGINEERING BULLETIN</b>	Document #:	<b>EB-02-17</b> <small>(Form: DEF-003A-1)</small>
	Document Title:		<b>Wet-R-Dri Valve Product Family Changes and New Product Introduction</b>	Revision:
		Date:		<b>Jun. 2018</b>
		Page:		<b>3 of 4</b>

**Part Number Changes:**

Betts' locking and metering WRD models (Model Type 2 & 4) are now obsolete and replaced with the new 8 position metering model (Model Type 6). The new metering model has a 8 position metering plate with a new lightweight metering handle (Sizes 2-5"). The new lightweight handle is built with less components and is approximately 1.25" shorter than the prior metering handle (sizes 2-5"). Example part numbers shown below.

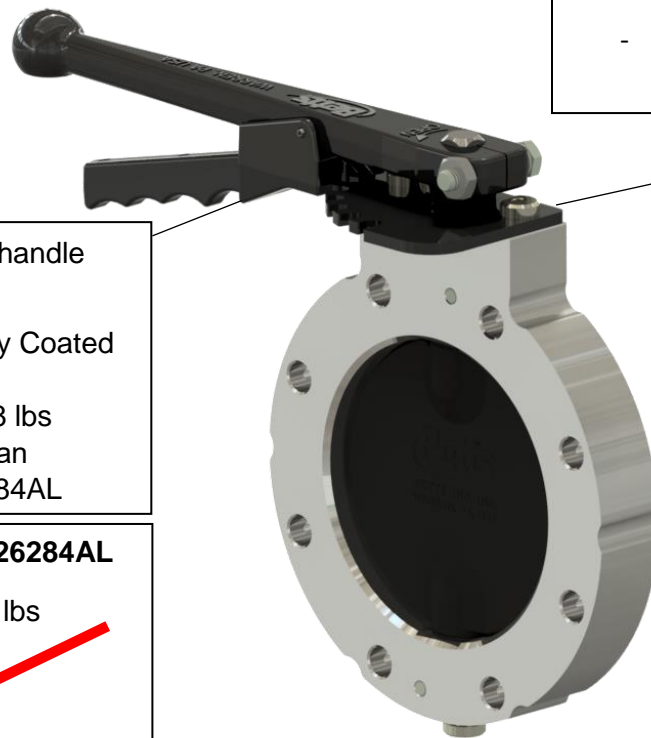
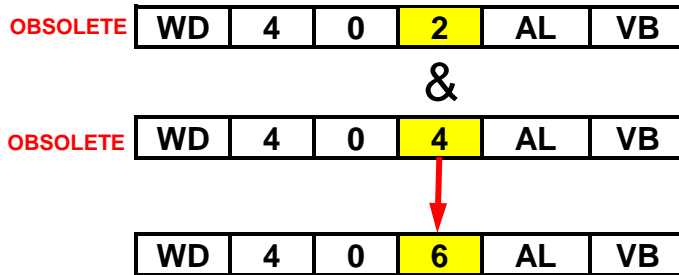

**8 Position Metering Plate**

- Allows for 8 different positions

**28981ALEY-** Metering handle assembly (sizes 2"-5")

- Aluminum Epoxy Coated Handle
- Est. Weight .628 lbs
- 1.25" Shorter than 26075AL & 26284AL

**Replaces 26075AL & 26284AL**

- Est weight .939 lbs



	Form Title:	<b>ENGINEERING BULLETIN</b>	Document #:	<b>EB-02-17</b> <small>(Form: DEF-003A-1)</small>
				Revision:
	Document Title:	<b>Wet-R-Dri Valve Product Family Changes and New Product Introduction</b>	Date:	<b>Jun. 2018</b>
				Page:

**New Model Type Option:**

Betts' now offers a hydraulic actuator for all Wet-R-Dri valves. When used in conjunction with Betts' hydraulic pump, a WRD valve can be remotely actuated without the need for tractor supplied pneumatic systems. The new hydraulic actuator allows for easy conversion from any Betts' pneumatic actuator model type 9 to hydraulic actuation. Example part number shown below.

WD	4	1	8	AL	VB
----	---	---	---	----	----



**29128AL** – Hydraulic actuator assembly

- Simplistic design
- Allows conversion from pneumatic actuation to hydraulic
- 1/4-18 NPT inlet

**Conversion of a Pneumatic Actuator (Model Type 9) to Hydraulic (Model Type 8)**

- Step 1 - Remove the 4 end plate bolts.
- Step 2 - Remove pneumatic endplate.
- Step 3 - Install hydraulic actuator assembly.
- Step 4 - Install 4 end plate bolts. Tightening gradually in a crisscross pattern.

